

Art. Nr. 2847296  
1/7



01.02.2024

Art. Nr. 2847296

Groundplan - Grundplan - Plan de masse - Planimetria - Plattegrond - Põhiplaan

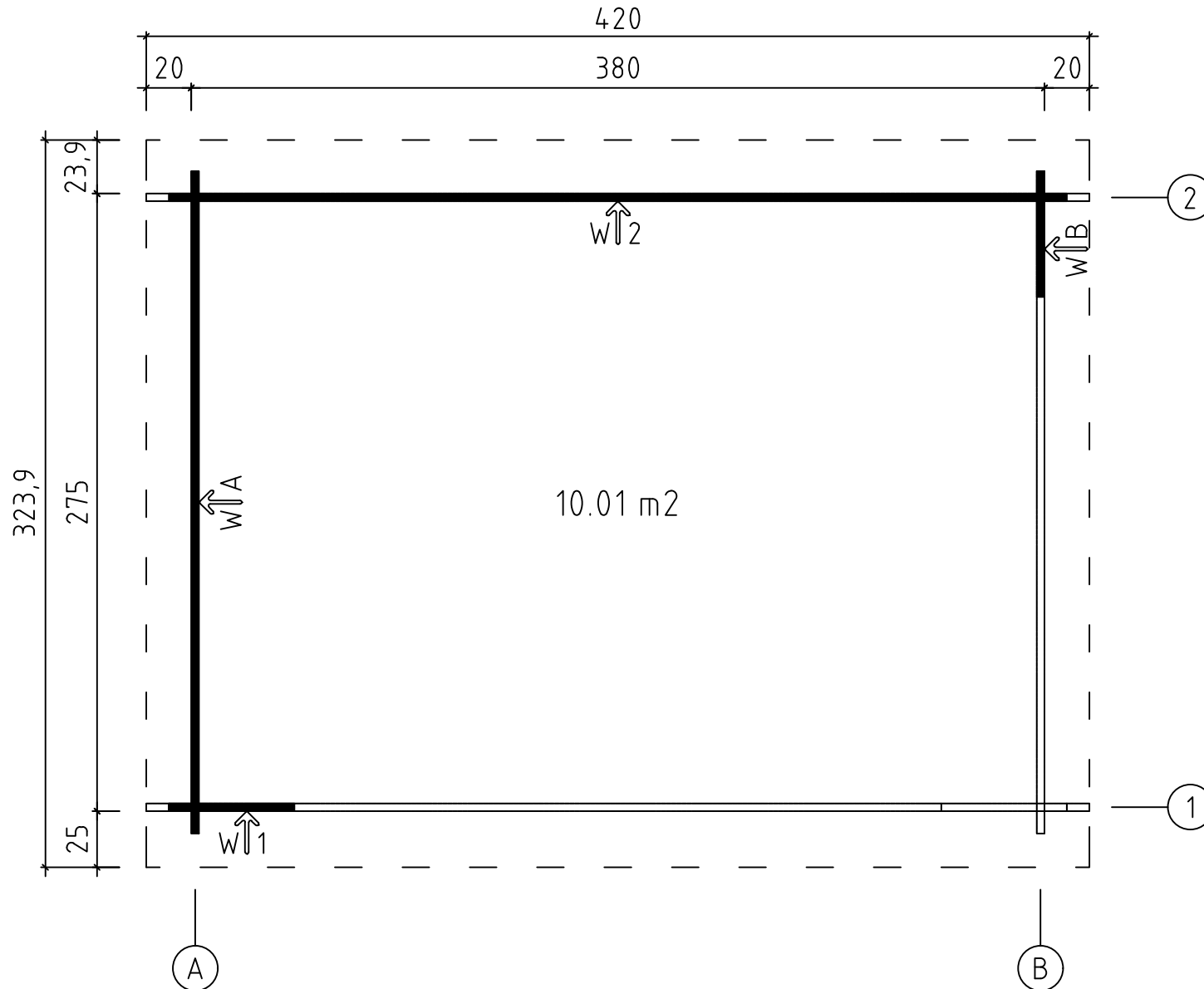



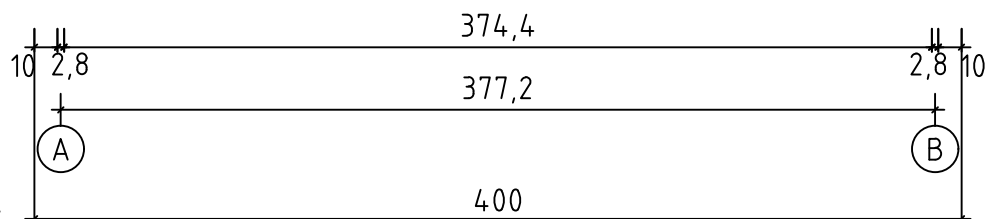
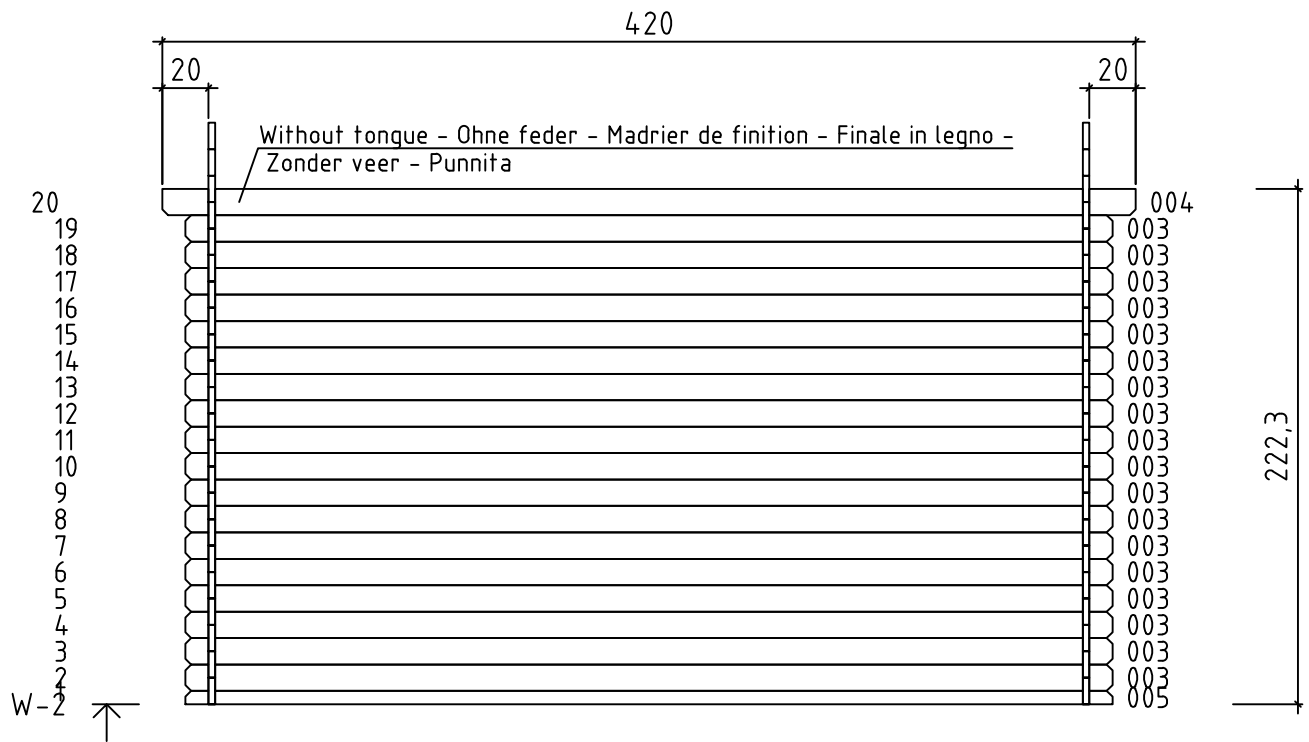
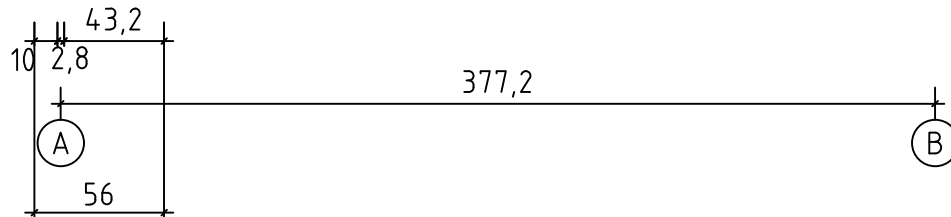
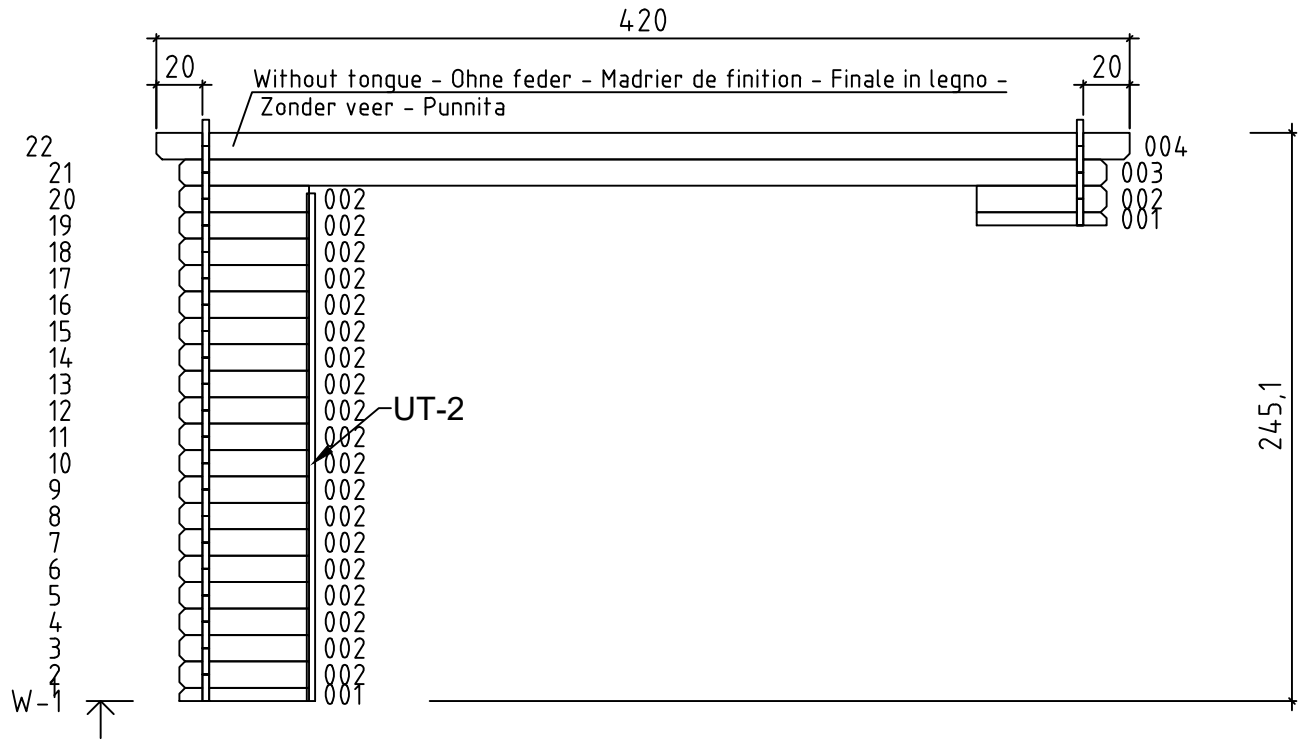



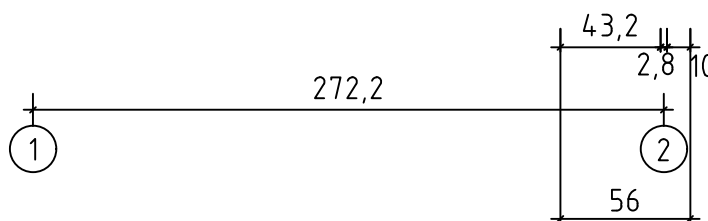
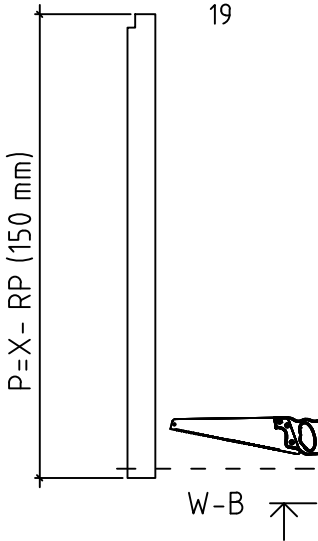
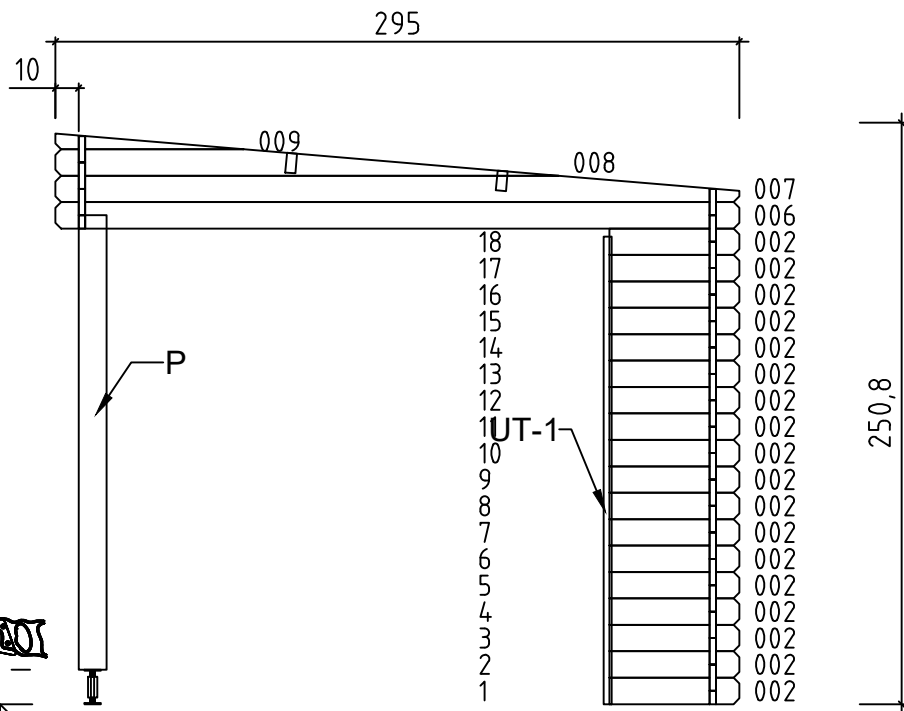
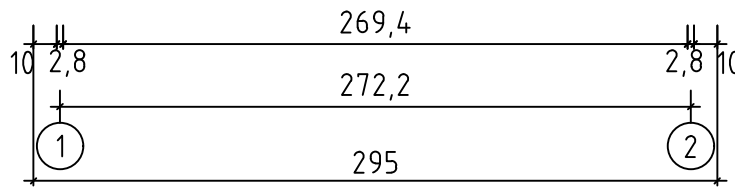
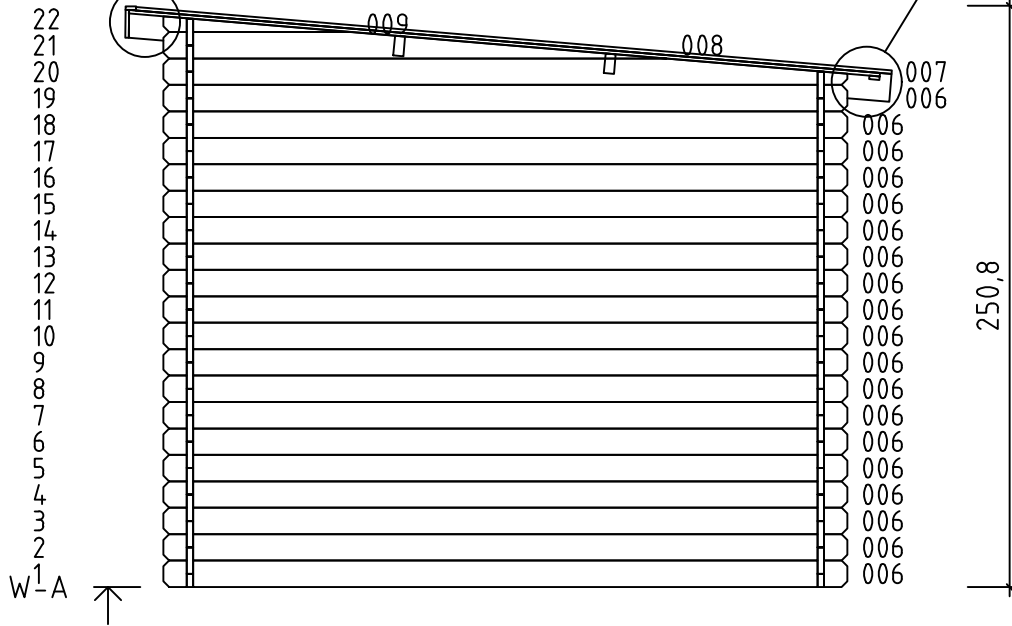
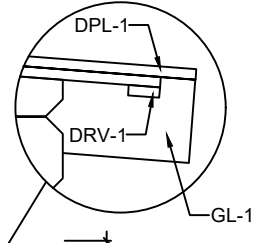
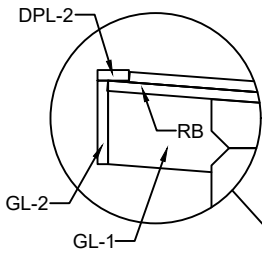

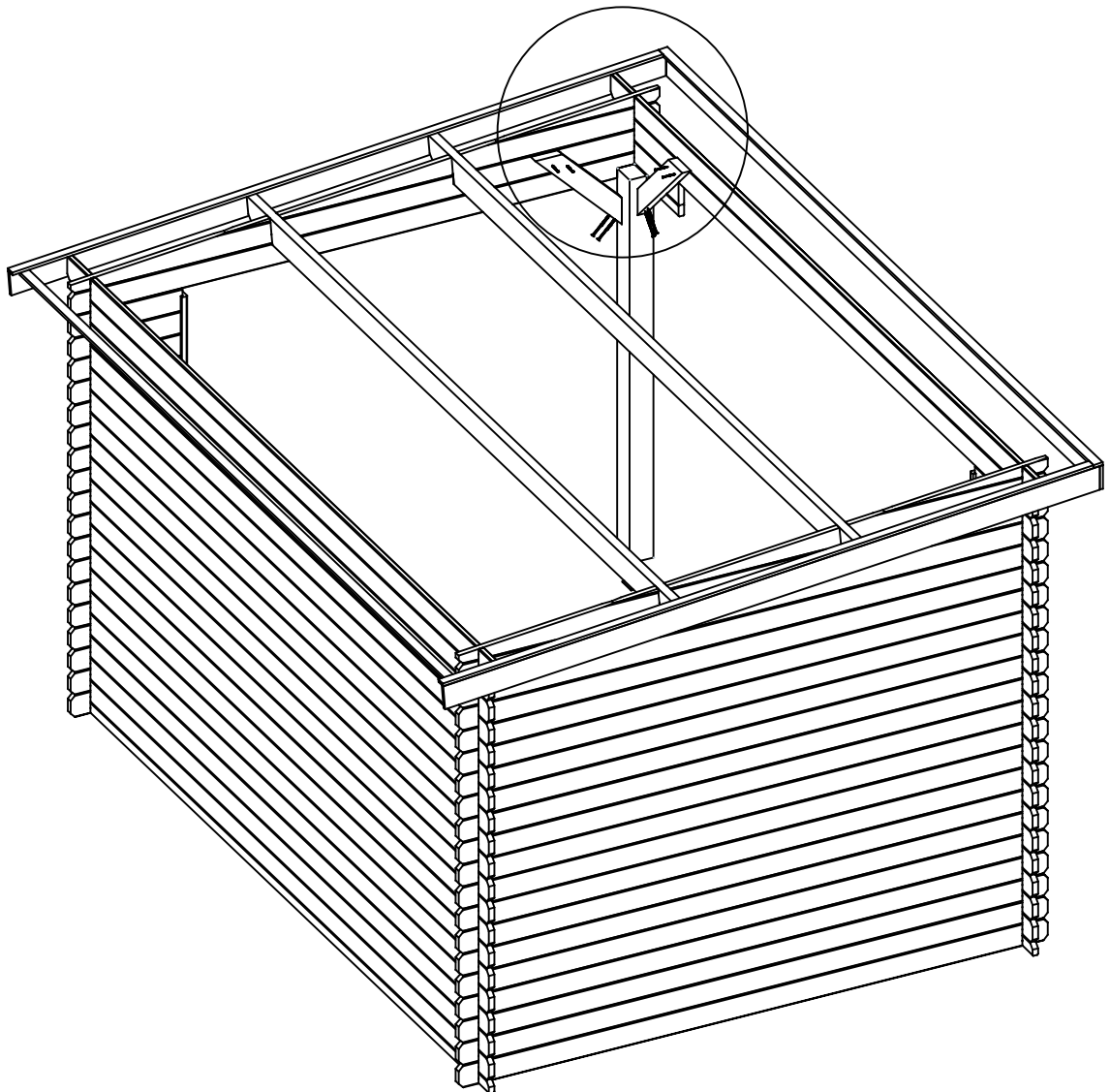
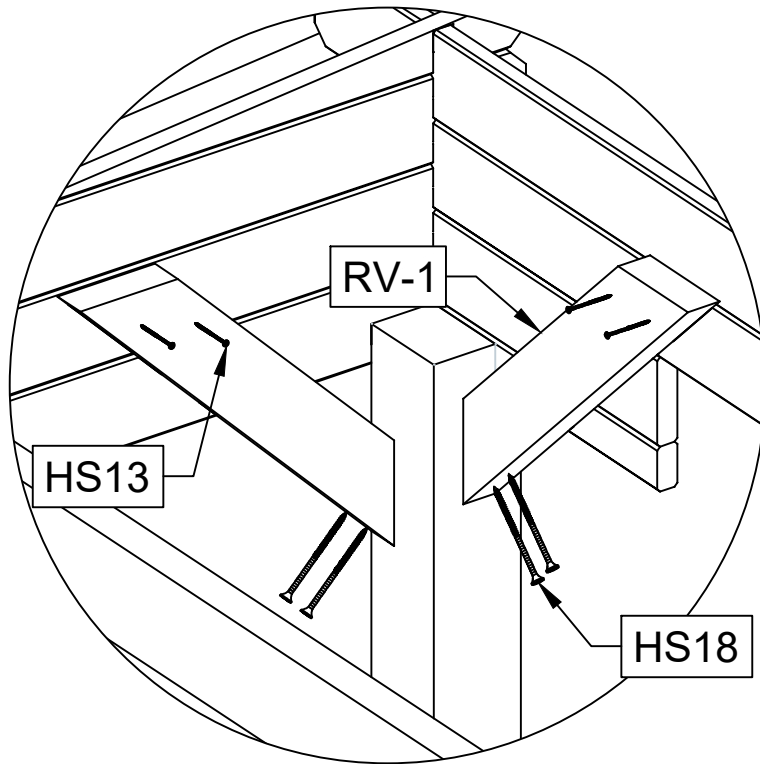

Art. Nr. 2847296

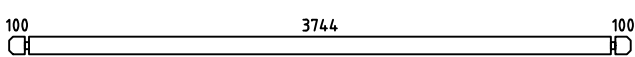
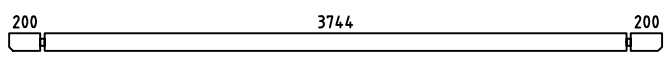
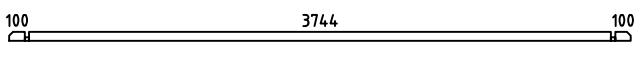
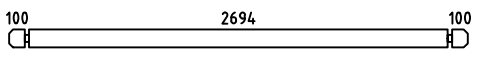
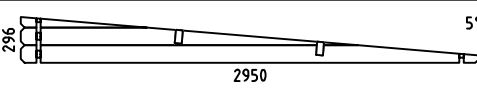
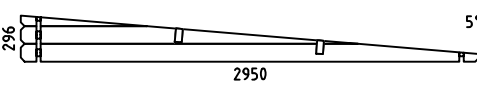
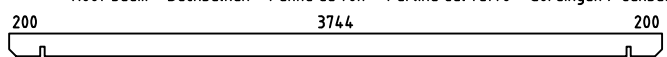
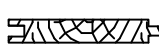

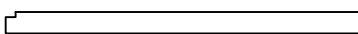
Art. Nr. 2847296

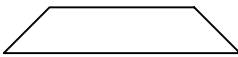

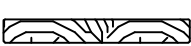
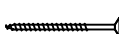

| Pos            | 01.02.2024<br>Piece list - Stückliste - Liste des pièces - Elementi - Stuklijst - Elementos - Tükítabel<br>Art. Nr. 2847296   | 6/7 | Q  | P<br>(mm) | L<br>(mm) |
|----------------|---|-----|----|-----------|-----------|
| 001<br>39463   |    |     | 2  | 28x57     | 560       |
| 002<br>39464   |    |     | 38 | 28x114    | 560       |
| 003<br>17110   |    |     | 19 | 28x114    | 4000      |
| 004<br>37478   |    |     | 2  | 28x114    | 4200      |
| 005<br>21407   |    |     | 1  | 28x57     | 4000      |
| 006<br>10854   |    |     | 20 | 28x114    | 2950      |
| WA-1<br>39465  |    |     | 1  |           |           |
| WB-1<br>39465  |    |     | 1  |           |           |
| A-PR1<br>35092 | Roof beam - Dachbalken - Panne de toit - Perlina del tetto - Gordingen / dakbalk - Correa - Pärlin<br>   |     | 2  | 44x146    | 4200      |
| RB<br>39466    | Roof boards - Dachbretter - Voliges - Perlina per tetto - Dakhout - Tablero de tejado - Katuselaud<br>   |     | 47 | 90x15.5   | 3250      |
| DPL-1<br>39467 | Roofing felt fillet - Dachpappenleiste - Baguette de fixation du feutre bitumeux - Asse per fissaggio guaina bituminosa - Afdeklijst asfaltpapier - Moldura de fieltro para tejado - Katusepapiilist<br>     |     | 2  | 15x45     | 3270      |
| DPL-2<br>39484 | Roofing felt fillet - Dachpappenleiste - Baguette de fixation du feutre bitumeux - Asse per fissaggio guaina bituminosa - Afdeklijst asfaltpapier - Moldura de fieltro para tejado - Katusepapiilist<br>     |     | 1  | 15x45     | 4230      |
| P<br>39468     | Post - Pfosten - Poteau - Piede registrabile - Stijl - Poste - Post<br>   |     | 1  | 120x120   | 2000      |
| DRV-1<br>26490 | Roof edge reinforcement - Dachrandverstärkung - Corniere de renfort de bord de toit - Rinforzo x tetto - Dakrand versterking - Refuerzo de aleros - Räästafugevdus<br>                                       |     | 1  | 15x45     | 4200      |
| RV-1<br>34799  | Beam - Balkenlage - Solive(s) - Trave - Balk (gording) - Viga - Tala<br>   |     | 2  | 44x120    | 620       |
| KFS-1<br>27180 | Storm protection - Sturmleiste - Latte anti-tempete - Protezione anti vento - Stormverankering / beveliging - Moldura antitormenta - Tornikinnitusliist<br>   |     | 3  | 22x45     | 2500      |
| UT-1<br>35094  | U-profile - U-profils - Profile u - Profilo ad u - U-profiel - Perfil en U - U-profiil<br>   |     | 1  | 28x58     | 2017      |
| UT-2<br>35095  | U-profile - U-profils - Profile u - Profilo ad u - U-profiel - Perfil en U - U-profiil<br>   |     | 1  | 28x58     | 2190      |
| GL-1<br>39469  | Gable moulding - Giebelleiste - Planche de rive - Finitura per frontale e retro del tetto - Gevellijst - Tablero de frontón - Viilulaud<br>   |     | 2  | 15x120    | 3300      |
| GL-2<br>32852  | Gable moulding - Giebelleiste - Planche de rive - Finitura per frontale e retro del tetto - Gevellijst - Tablero de frontón - Viilulaud<br>  |     | 1  | 15x120    | 4230      |
| HS9<br>5106    | Screw for u-profile - Schraube zur befestigung u-profils - Vis a tete fraisée pour profil u - Vite per profilo ad u - Schroef ter bevestiging u-profiel - Tornillo para perfil en U - Kruvi U-profiilite<br> |     | 12 | 3.5x50    |           |

